

WASTE FITTING KA 120 FLAT

- Complete set with enamelled waste cover
- Developed for low installation heights - ideal for renovations
- Universally applicable thanks to drain off connection and accessory adapter (DN50)
- Water seal height 30 mm

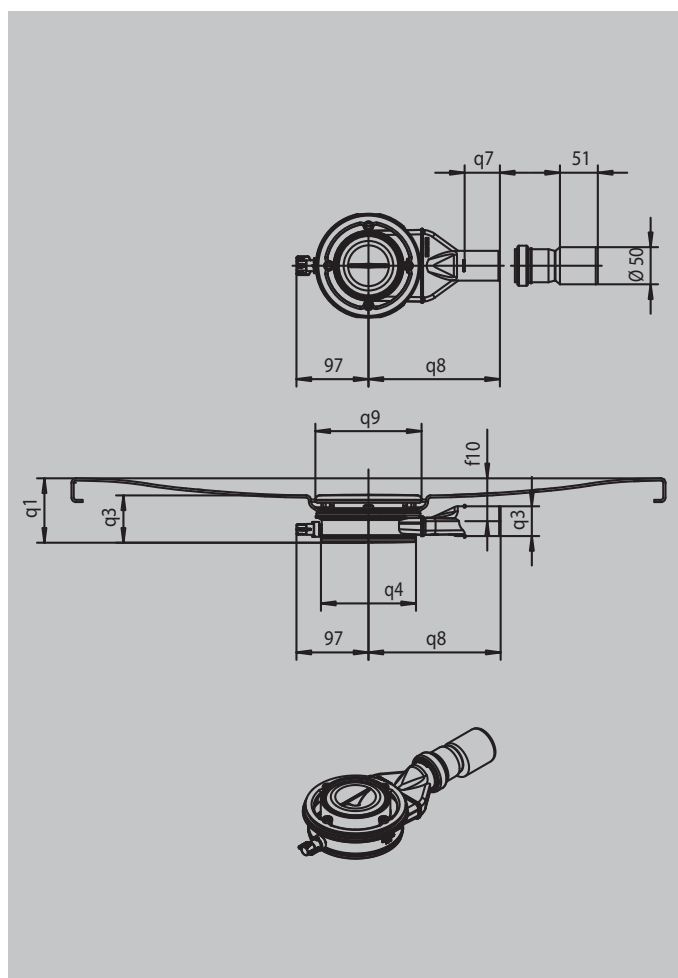

4101

Connection height siphon	f10	tray depth** +35 mm
Shower tray height with siphon	q1	tray depth** +63 mm
Installation height	q2	63 mm
Connection pipe diameter	q3	40 mm
External dimensions	q4	128 mm
Long connection pipe (can be cut to length)	q7	48 mm
Distance between the siphon axis and the connection pipe	q8	177 mm
External dimension of waste cover	q9	143 mm

We recommend the use of a backflow block. The total height and siphon may require installation in a floor recess.

Waste fitting KA 120 flat	Model Order No.	
Waste fitting KA 120 flat	4101 68777250xxxx	