

PURO BUILT-IN WASHBASIN

- elegant rectangular washbasin in a classically minimalist design
- reduced precise edges
- very generous interior dimensions
- clean and timeless lines – immortalised in long-lasting KALDEWEI steel enamel
- harmonises perfectly with the PURO bath series
- designed by Anke Salomon

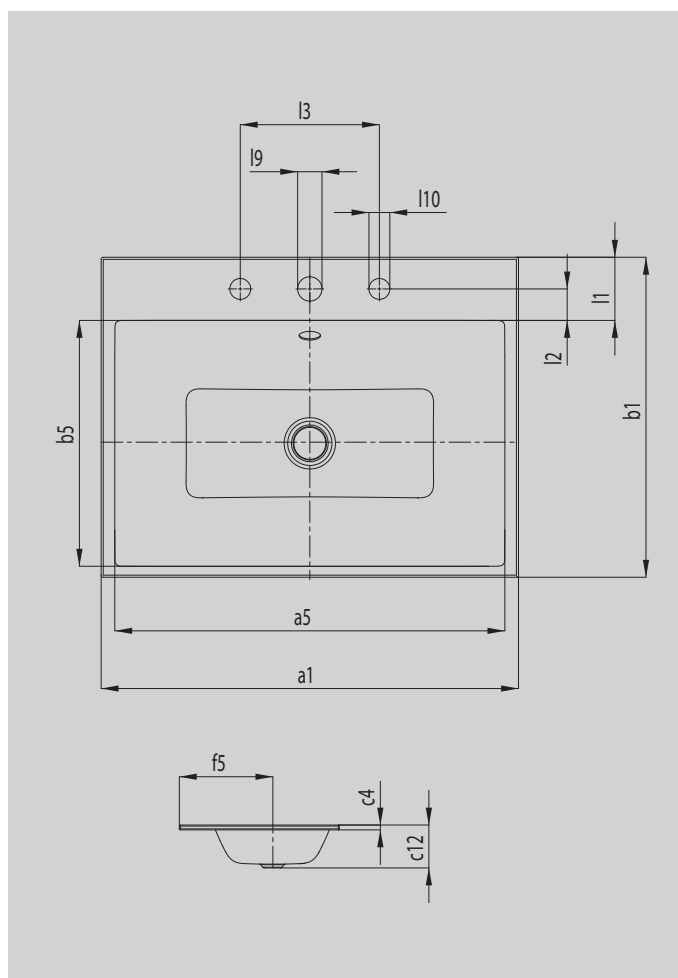

Similar illustration



Model		3150
External length	a_1	460 mm
Internal length	a_5	421 mm
External width	b_1	460 mm
Internal width	b_5	354 mm
Height of rim	c_4	14 mm
Distance basin surface to bottom edge of waste hole	c_{12}	115 mm
Distance rear edge to centre of waste hole	f_5	268 mm
Depth of tap deck	l_1	91 mm
Distance tap holes to edge	l_2	45 mm
Distance external tap holes (for 3 tap holes)	l_3	200 mm
Diameter of centre tap hole	l_9	Ø 35 mm
Diameter of outside tap hole (for 3 tap holes only)	l_{10}	Ø 30 mm
Net weight		6 kg