

CORNEZZA

- striking pentagonal shower tray
- space-saving shape
- generous standing area with lots of room to move when showering
- elegant corner solution
- made of KALDEWEI steel enamel
- flush-fitting recessed waste cover (only in combination with the KA 90 waste fittings)

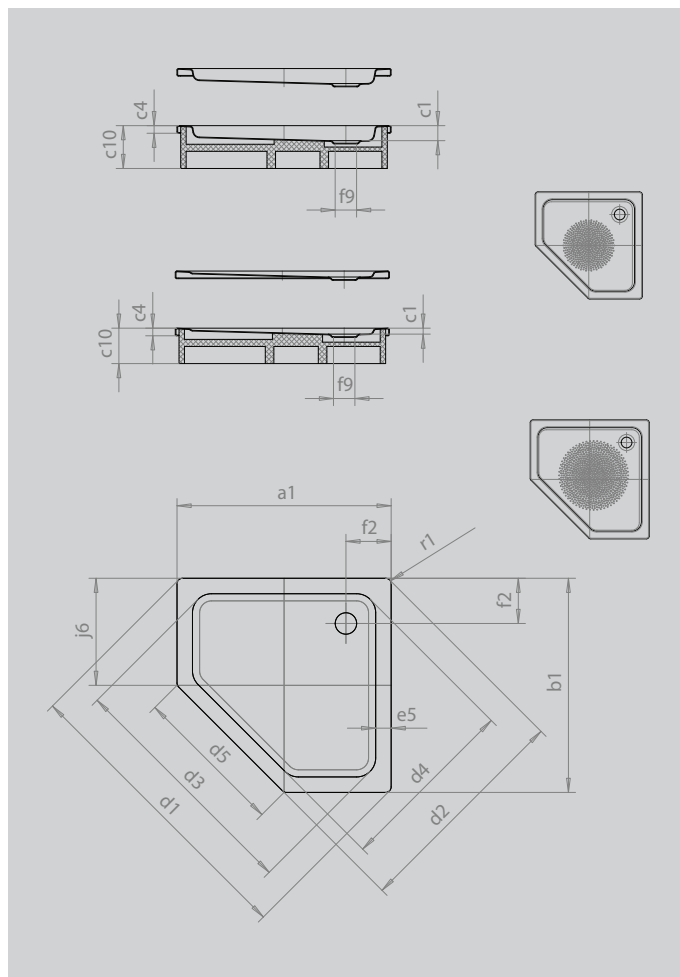

Similar illustration



Model		671
External length	a_1	900 mm
External width	b_1	900 mm
Depth inside	c_1	65 mm
Height of rim	c_4	32 mm
Height with support	c_{10}	120 mm
Height with low-profile support	c_{16}	49 mm
Width across corners - external length	d_1	1254 mm
Width across corners - external width	d_2	945 mm
Width across corners - internal length	d_3	1023 mm
Width across corners - internal width	d_4	765 mm
Width of access area	d_5	636 mm
Width of rim	e_5	65 mm
Distance bath edge to centre of waste hole	f_2	190 mm
Diameter of waste hole	f_9	Ø 90 mm
Side length	j_6	450 mm
External radius	r_1	23 mm
Net weight		20 kg
Diameter of anti-slip		Ø 435 mm