

# CORNEZZA

- striking pentagonal shower tray
- space-saving shape
- generous standing area with lots of room to move when showering
- elegant corner solution
- made of KALDEWEI steel enamel
- flush-fitting recessed waste cover (only in combination with the KA 90 waste fittings)

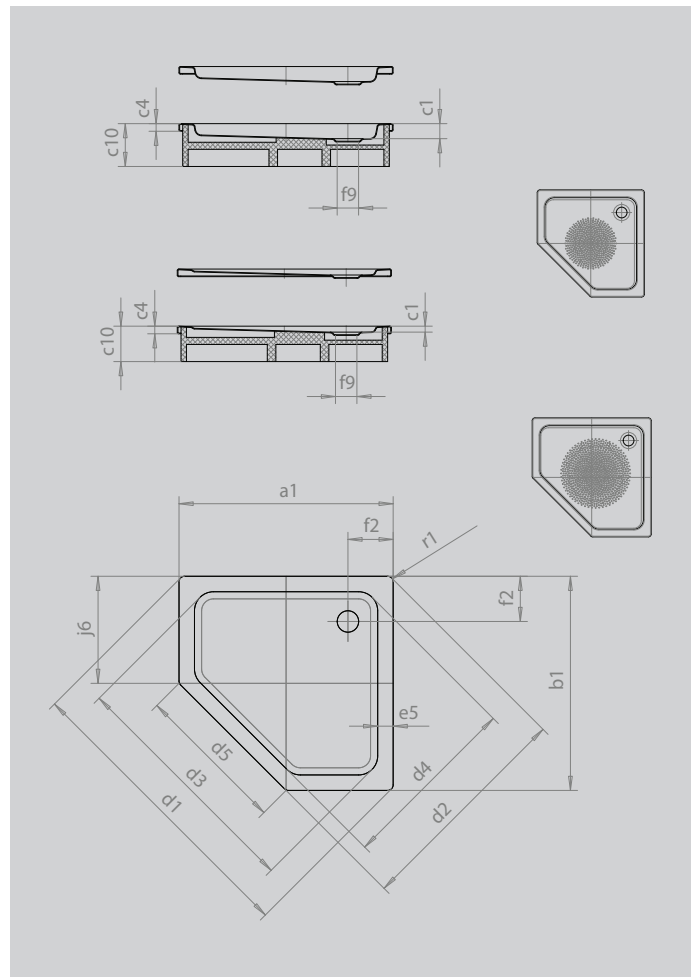

Similar illustration



Model		670
External length	$a_1$	900 mm
External width	$b_1$	900 mm
Depth inside	$c_1$	25 mm
Height of rim	$c_4$	32 mm
Height with support	$c_{10}$	120 mm
Height with low-profile support	$c_{16}$	49 mm
Width across corners - external length	$d_1$	1254 mm
Width across corners - external width	$d_2$	945 mm
Width across corners - internal length	$d_3$	1023 mm
Width across corners - internal width	$d_4$	765 mm
Width of access area	$d_5$	636 mm
Width of rim	$e_5$	65 mm
Distance bath edge to centre of waste hole	$f_2$	190 mm
Diameter of waste hole	$f_9$	Ø 90 mm
Side length	$j_6$	450 mm
External radius	$r_1$	23 mm
Net weight		19 kg
Diameter of anti-slip		Ø 435 mm